

Article number: 23052102416

Description: E+G Crank handle
EKH.100-A12-C6, red cap

Measures

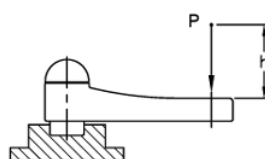
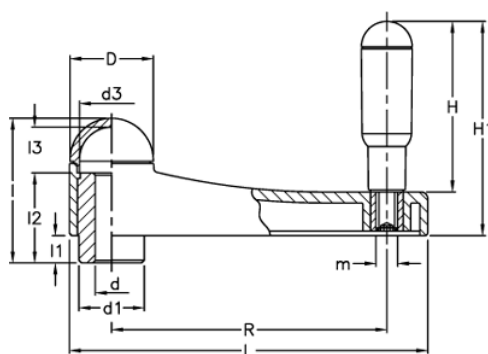

$$L[J]=P[N] \cdot h[m]$$

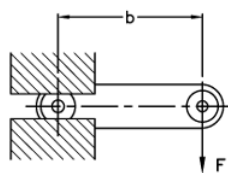

$$C[N \cdot m]=F[N] \cdot b[m]$$

C (N m) = 200	L = 131.5
d = 30.5	L (J) = 27
d1 = 24	l1 = 10
d3 = 23.5	l2 = 33
d H7 = 12	l3 = 17
H = 73	m = M8
H1 = 89.0	R = 101
l = 52.5	